

"Tidemark Requirements for Construction"

1. Letter from owner stating work to be done including contractors name and telephone number.
2. \$750.00 deposit check needs to be made payable to Key Colony 1 Condo. Assoc.
3. Signed contractors' packet with both the owners and contractors signature.
4. Copies of the company licenses for anyone working on the project.
5. Copies of workers comp for anyone working on the project.
6. Certificate of Insurance for anyone working on the project naming "Key Colony 1 Condo Assoc. 201 Crandon Blvd. Key Biscayne, Fl. 33149" as certificate holder. Please include unit number in the description section which is above the certificate holders section. **The certificate of insurance will only be accepted if sent to us directly from the insurance company.**
7. 3 copies of the plans showing the proposed changes.

"CONSTRUCTION RULES"

Chipping Hammer

1. Arrangements need to be made with the office at least 24 hours in advance.
2. Chipping will only be authorized Monday, Tuesday & Thursdays.
3. 2 days maximum allowed to chip for 1 & 2 bedroom apartments and 3 days maximum for 3 or more bedrooms (2 days one week & 1 day another week).

Sprinkler Shut Down

1. Arrangements need to be made with the office at least 48 hours in advance.
2. Shut downs will only be scheduled for Monday, Tuesday & Thursdays.
3. The first shutdown will be complimentary. There will be a \$30 charge for each additional one that will be deducted from the construction deposit.

Water Shut Down

1. Arrangements need to be made with the office at least 48 hours in advance.
2. There will be a \$60 charge for each shut down performed that will be deducted from the construction deposit.

Debris Removal & All Deliveries

1. Arrangements need to be made with the office at least 24 hours in advance.
2. We will cover the carpet each time, the first 2 times are complimentary. There will be a \$50 charge for each additional time that will be deducted from the construction deposit.

3. Tile Delivery: Tiles will need to be taken up little by little (weight must be distributed evenly within the elevator). All tiles and installation materials must be placed inside the unit by 5pm. The receiving area must be cleaned and all palettes removed by then (NO EXCEPTIONS).
4. Dumpster: Please call the office to make arrangements at least 48hrs in advance. Contractors are responsible for bringing plywood to be placed under the dumpster to protect the flooring. Also, please make sure to cover the dumpster every day before leaving. They can only remain on premises for a maximum of 48hrs, they must be picked up by 4pm of the day in which they are scheduled to be picked up. (UNDER NO CIRCUMSTANCES CAN THEY STAY OVER THE WEEKEND).

Please be advised that nothing can be left in the receiving area

Tile Installation

1. The office will need to inspect the soundproofing and/or waterproofing prior to any flooring material being installed. Please call 24 hours in advance to schedule the inspection.
2. All tile cutting must be done inside the apartment (NOT ON BALCONIES).

General

1. During remodeling project all windows and doors must remain closed (SPECIALLY FRONT DOOR).
2. Place a floor mat on the outside of the front door in order for those exiting the apartment to clean their feet instead of trekking the dirt all over the hallway carpet. At the end of the day, the floor mat must be placed inside the apartment and the contractor must make sure that the area outside of the unit and hallway is properly cleaned. Any area left dirty will be cleaned by us and

we will deduct the cleaning fee from the construction deposit.
Amount to be determined at time of need.

3. Contractors and their employees must use the bathrooms inside the apartment for the duration of the remodeling project. Please make sure to have a functioning bathroom at all times. (UNDER NO CIRCUMSTANCES MAY THE WORKERS USE THE BUILDINGS BATHROOMS).

Revised 7/18/16

MEMORANDUM

TO: All Contractors
FROM: Tidemark Management
DATE: July 7, 2016
RE: Hallway Cleanliness

Apartments under construction need to place a mat on the exterior of the apartment front door. This mat needs to be removed and the area needs to be cleaned daily.

Please be advised that effective immediately we will begin charging a cleaning fee on an as need basis the amount to be determined depending on the need. We will check all the areas at 5pm daily and whenever we see that the area outside of the apartment is dirty, we will call the contractor to advice and will proceed to clean the area and deduct the fee from the construction deposit.

Contractor Signature

Unit #

Date

CONTRACTOR WORK PROCEDURE FOR TIDEMARK

The Association requires a refundable damage deposit of \$750.00 for construction work of any kind. Deposits must be made to the Association office before any work can commence. All preliminary plans and drawings must accompany the construction agreement and deposit. The Association will not allow any work in the unit until proper documentation and deposits have been presented.

After a work is completed and the common area has been inspected for any damages, the deposit will be refunded to the resident. If damages occur the office will contact the resident prior to deducting any funds.

Only licensed and properly insured contractors are allowed to work in the condominium. Copies of license and insurance (workers comp and liability) must be submitted to the Association office along with construction agreement. All contractors must sign and abide with the Tidemark compliance for interior remodeling and Rules and Regulations.

All work such as air conditioning, electrical, sprinkler system, plumbing, flooring, cabinets and demolition require a permit. Permits must be applied for and obtained by a licensed contractor. The village of Key Biscayne requires a letter of approval from the condominium Association in order to process permit applications. A letter of approval will only be issued once the submitted plans have been approved and Management has verified your contractor information. All necessary permits must be obtained before work begins or the job will be stopped No Exceptions and the Village of Key Biscayne notified.

Any work conducted in the unit that involves relocating or cutting of the fire sprinklers cannot start without a permit from the Village of Key Biscayne. Only properly licensed companies are permitted to work on the sprinkler system. The General building permit is not sufficient for work on the sprinkler system. Enclosed please find the sprinkler guidelines provided by the Key Biscayne Fire department.

Inspection of all floors soundproofing by the Association is required. No tile, stone, or wood flooring or carpet can be installed without proper soundproofing and/or padding. Key Biscayne Village permit must also be obtained. All inspections will be made on complete installation of soundproofing. The building must also inspect the soundproofing; therefore prior to commencing the installation of hard flooring contact the Manager's office.

If a dumpster is required, arrangements for scheduling must be made with the Association office. The dumpster is ONLY permitted in the designated area from Monday through

Friday and for a maximum of two days. NO DUMPSTER IS ALLOWED ON THE PROPERTY ON HOLIDAYS OR WEEKENDS.

All lobby marble and hall carpeting must be protected with runners from the freight elevator to your unit.

The damage deposit is required for ANY TYPE OF WORK major or minor in case of damage to the common areas. Please be aware that you are responsible for any damages caused by your contractor and vendors, such as scratching of paint in the freight elevator doors, unit doors, columns or wallpaper, chips or cracks in the thresholds or lobby marble, stains or damages to the new carpet. No covering of front door.

1. Working hours are from 9:00 AM to 5:30 PM Monday to Friday. **No work is allowed on weekends or holidays. No contractor may utilize the Association restrooms.**
2. NO CONSTRUCTION ACTIVITY WILL BE ALLOWED DURING THE PERIOD COMMENCING IN THE CALENDAR WEEK IN, WHICH CHRISTMAS DAY OCCURS, AND ENDING AFTER THE CALENDAR WEEK IN WHICH NEW YEAR'S DAY OCCURS.
3. All workers are required to check in at the receiving area at the front of the building to sign. All tools and materials must be off-loaded at the receiving area as well as workers vehicle(s) parked in the visitors parking area of the garage.
4. Shopping carts are not to be used to transport workers supplies or materials. **THESE SHOPPING CARTS ARE FOR RESIDENTS USE ONLY.**
5. Workers are not allowed to use the passenger elevators at any time. All tools, equipment and materials must be transported via the service elevator from the 1st floor.
6. No work can be performed in hallways, lobbies and/or emergency exists nor can these areas be used for storage of old or new construction materials.
7. No owner may remove or relocate the Association alarm system or evacuation speaker. Any unit not following these procedures must adhere to pay all expenses to repair original equipment. Any persons found tampering with the alarm system is subject to fines from the Key Biscayne fire department.
8. All paint, paint thinner, chemicals, etc., which are considered a fire hazard must be properly maintained within the unit at all times. Owners and their contractors and/or subcontractors are responsible for any misuse and damage caused by improper control of these items.
9. Drilling into floor slabs or the ceiling is strictly prohibited without the approval of the Association or without advance x-ray to prevent damage to post tension cable system. Contractors are allowed to use chipping hammers. The condominium will ONLY allow

45 pound chipping hammers. If drilling or heavy/loud demolition is to be done (in any area of the unit) at least two days notice must be given to the Association office to allow time to notify surrounding unit owners of the noise to be expected.

10. For balconies receiving new flooring, a water proofing membrane as specified by the Association must be installed. All waterproofing membrane must be inspected by the condominium once the waterproofing membrane has been laid out and before any new flooring may be installed. An installation of flooring prior to inspection is subject to tile removal. No carpeting may be installed on balcony or lanai flooring.

11. When all work is finalized in your unit, the resident/contractor must contact the Association office. For all work requiring permits, copies of finalized permits must be submitted to the Association office. In order to issue the security deposit refund a final inspection of the common area must be conducted.

12. Under no circumstances shall construction debris be placed in the building trash chutes or trash rooms.

13. No common area or limited common area such as balconies or lanais shall be used by workers of any craft to store, size, cut or repair any material or object of any kind, unless previously approved areas with clean up immediately thereafter. Noise shall be kept at the minimum level possible.

14. Apartment doors shall be kept closed at all times when work is being done.

15. No owner shall make any structural addition, alteration or improvement of the whole or any part of the unit, including but not limited to balconies, without notifying the Association. No owner shall make any additions or alterations to any common element.

Unit Owner Signature

Date

Contractors Signature

Date

(Copies of contractor license and required insurance must be attached to this form)

DESCRIPTION OF WORK BEING PERFORMED:

Kitchen

Bathroom/Plumbing

Floors (All hard surfaces such as tile, marble, wood require specified soundproofing)

Other

ALL DEPOSIT CHECKS MUST BE LEFT WITH THE OFFICE BEFORE ANY WORK IS STARTED.

REVISIONS ARE SUBJECT TO NECESSARY PERMITS BEING OBTAINED BY A LICENSED CONTRACTOR.

*******FOR OFFICE USE ONLY*******

DATE WORK COMPLETED: _____

COMMON AREAR INSPECTED BY: _____

FINAL PERMITS PROVIDED: _____

DEDUCTIONS: _____

AMOUNT RETURNED: _____

PREPARED BY: _____

I, _____ owner of unit # _____, am in the process of remodeling and raising the kitchen ceiling. In order to conduct such work in the unit I understand that I must abide by the following guidelines:

Only a certified sprinkler contractor is allowed to work on the sprinkler system. (A copy of your company's license and insurance must be submitted to the administration office before any work is permitted.)

Proper permits must be obtained through the Village of Key Biscayne. In order to obtain a permit, your contractor or sprinkler company must submit an application, along with a plan exemplifying the scope of the work.

Once the permit is obtained from the V.K.B, the permit must be posted in an evident location in the unit. Also, a copy of such must be provided to the administration office.

In order to make the necessary arrangements with the Key Biscayne fire department and the appropriate individuals within the condominium, the owner, contractor or sprinkler company must give ample notification to the administration office. No work will be permitted without proper notification.

Scheduled shut downs for sprinklers work, should take less than four hours. Any work requiring the sprinkler line to be shut off for more than four hours, requires special arrangements through the association office.

Once all the above procedures have been followed, your sprinkler company may begin work in the unit.

Upon completion of the work, notification must be given to the office.

To obtain a final permit, the unit owner, contractor or sprinkler company must contact the building department to coordinate the necessary inspections.

Copies of final approval must be presented to the association office.

I have read and understood all the above. I also understand that it is my responsibility to insure that my contractor and subcontractors are aware of the above-mentioned.

Agreed by OWNER

Agreed by CONTRACTOR



KEY COLONY No. 1
CONDOMINIUM ASSOCIATION INC.

REV: 10/2001

TO : UNIT OWNERS/ CONTRACTORS

RE : ADDITIONS, ALTERATIONS OR IMPROVEMENTS
(Declaration of Condominium, Paragraph 9.1)

Improvements, Addition and Alterations to a Unit must have the prior written consent of the Condominium Association and all the necessary building permits from the Village of Key Biscayne. A complete set of drawings and specifications must be submitted to the Manager's office in order to get the Condominium approval, which is required to obtain a permit from the Village of Key Biscayne.

The following rules will be strictly observed:

- Working Hours are from 9:00 AM TO 5:30 PM Monday through Friday (Except Holidays).
- Drilling into floors is strictly prohibited unless complete x-rays are taken prior to and with management approval.
- Under no circumstances can work be performed on the fire sprinkler system until the Condominium Association is notified 24 hours in advance in order to properly drain the system and notify the Fire Department. The fire sprinkler contractor must be licensed to perform this particular work.
- Unit owners who intend to replace their existing flooring with a new hard floor such as wood, parquet, ceramic tile, marble etc., must insure that it is adequately soundproofed (contact the Manager's office for details). Balconies, patios and decks are subject to the same requirements. *for waterproofing*
- Unit owners must insure that contractors are advised that debris materials are not to be placed in the trash chutes. Contractors will be held responsible for damages to the trash chute and trash equipment. The contractor must remove all trash and construction debris from the property. If a trash container is used, trash must be collected inside the apartment until there is enough debris to fill the container. Upon delivery, containers must be removed from the property within 48 hours.
- All equipment, building materials, debris, etc., must be transported through the freight elevator. Passenger elevators **can not** be used under any circumstance. Extreme care must be taken not to soil or damage common area carpeting or wallpaper. Plastic "carpet runners" must be taped to carpet between freight elevator and apartment. **Contractor will be charged** for the cost of cleaning or replacement of any damaged carpeting or wallpaper.
- All contractors are required to place a \$750.00 damage/clean-up deposit with the Condominium Association, which shall be held in a non-interest bearing account. A Deposit Agreement must be duly signed by the Contractor and the Condominium Association.

COMPLIANCES FOR INTERIOR REMODELING

1. Cover daily all the passageways when construction debris is being remove from the unit from the elevator to the apartment.
2. Maintain passageways clean during working hours.
3. Leave passageways clean at the end of the working day.
4. Balcony scupper must be covered during balcony floor installation.
5. Any change(s) during construction must be submitted to the association for approval.
6. Sign and acknowledge that all requirements and provision have been met.
7. Sign and acknowledge that a full understanding of the remodeling procedures.
8. Security will check passageways daily.
9. The association will collect costs of replacement or repair of any and all damage to common areas before work may continue.
10. No use of building carts will be permitted.
11. There is no access to pool deck. Violators will be charged with trespassing.
12. There will be use of the freight elevator only. Under NO circumstances should the passenger elevator be used with or without materials.
13. All vehicles will be parked daily at the receiving parking area. No vehicles will park in the garage visitor parking.

Date

Contractor Signature

Name

CONSTRUCTION REGISTRATION

UNIT NUMBER: _____

UNIT OWNERS NAME: _____

SIGNED CONTRACT AGREEMENT: _____

CHECK # _____

COMMON AREA INSPECTION WITH RESIDENT: _____

PICTURES OF COMMON AREA ACKNOWLEDGEMENT: _____

PLANS: _____

GENERAL CONTRACTOR: _____

CONTRACTOR'S LICENSE: _____

LIABILITY INSURANCE: _____

WORKERS COMPENSATION INSURANCE: _____

PERMIT LETTER APPROVAL: _____

SIGNED RULES AND REGULATION AGREEMENT : _____

PERMIT # _____



VILLAGE OF KEY BISCAINE

Department of Building, Zoning and Planning

Village Council

Robert L. Vernon, Mayor
Michael Davey, Vice Mayor
Enrique Garcia
Robert Gusman
Michael E. Kelly
Jorge E. Mendia
Thomas Thornton

June 22, 2009

Director

Jud Kurlancheek, AICP

Chief Building Official

Eugenio M. Santiago, P.E.

Village of Key Biscayne Condominium Managers:

RE: Floor Covering New Permit.

After repeated requests from your offices and several contractors to issue permits for tile installation, new permits will be required for this work.

This letter is to inform you starting June 29, 2009; a permit will be required to install all types of coverings such as marble, ceramic tiles, wood, wood laminate vinyl tile and sheet vinyl, carpeting and any other type of floor covering.

When requesting these permits, the same permit form used for other permits will be used. Floor installer license issued by Miami Dade County will be required as minimum qualification. Proper insurance certificates will be required in order to obtain such permit.

The sound proofing specifications supplied with the permit shall be the ones required by each one of your properties. They must comply with FBC 2007 requirements.

Inspections for this job will be soundproofing installation and final inspection. The soundproofing shall be requested the same day as the inspection from your property inspection.

The charges for this permit will be a flat fee of \$ 106.00.

Any questions contact me thru email or at my office at 305-365-8917.

Thank you,

Sergio Bonich
Senior Code Enforcement Officer

Protecto WhisperMat

By Protecto Wrap

Sound Control &
Crack Suppression Membranes
for Ceramic and Natural Stone Tiles



Serious Waterproofing Solutions

ProtectoWhisperMat-

Sound Control and Crack

New Construction, Remodeling, Resi

WhisperMat-CS is a peel & stick sheet membrane that reduces impact and air-borne sound transmissions, and isolates "finished" flooring from subfloor cracks. Designed for use with ceramic and natural stone tile where sound absorption is required, specified or desired.

Constructed of a Cross Linked Poly-Olefin foam sheet combined with aggressive rubberized adhesive and a polyester mesh fabric, WhisperMat-CS also has the flexibility and strength to withstand structural movement and concrete shrinkage cracks up to 1/4" without transferring stress load to finished tile. Additionally, excellent chemical and moisture resistant properties make this the most comprehensive underlayment product for ceramic and natural stone available.



PROPERTIES AND ADVANTAGES

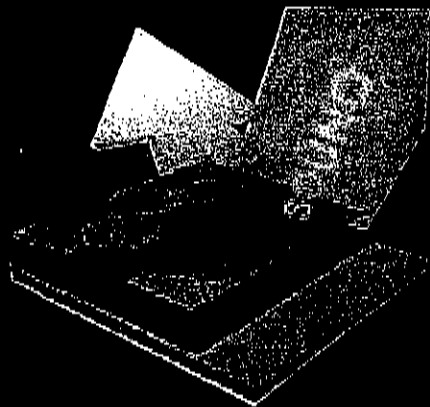

- Sound Reduction: IIC: 71 STC: 72
- Moisture and Chemical Resistant
- Anti-Fracture Resistant to 1/4"
- Thermal Insulation
- High Commercial Load Rating
- Approved over Most Wet Laid Subfloors
- Unique Thin System (110 mil)
- Economical

WhisperMat CS Composite

Layers in order, top to bottom:

Reinforced Polyester Mesh Fabric

Aggressive Rubberized Adhesive

Dense, Cross-Linked Poly-Olefin foam

Aggressive Rubberized Adhesive

Release Paper

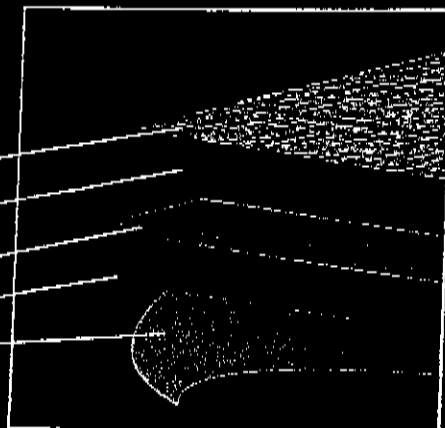



Apply Primer



Cut to Correct Length

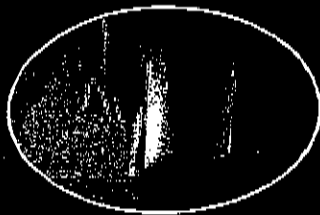

Remove & Press in Place

INSTALLATION:

Follow flooring manufacturer's recommended installation instructions. Installation and subfloor requirements must also conform to TCA standards. Flooring and membrane must acclimate to job site conditions before installation. Concrete subfloors must be dry, clean and free of dirt, grease, wax, paint, oil or anything that would adversely affect adhesion of the WhisperMat.

Subfloor must be checked for excessive moisture. If subfloor moisture/vapor is beyond 4lb. emissions WhisperMat-CS membrane cannot be used (see "Limitations"). Leveling cements must be completely dry before membrane application.

Priming the subfloor: Always apply the Protecto Wrap #6000 primer to the subfloor and allow to dry (approx 20-30 min.) before installing the WhisperMat-CS to ensure a good bond.

Unroll WhisperMat-CS with the release liner side down. Cut the length approximately 12" longer than the distance to be covered to allow for a

trimmed fit. Fold back half of the length of the roll back over the other half of the material. Score through the release liner only, taking care not to cut completely through membrane. Pull release liner away from membrane where scored. As the release liner is pulled away, hand smooth the membrane to contact the primed subfloor. Keep the release liner material close to the floor while pulling away, this will allow for a more controlled application of the membrane.

Take note: there will be an immediate and aggressive bond of the membrane to the primed subfloor. Realignment of the membrane can be difficult once adhered to the subfloor.

After WhisperMat-CS is adhered, ceramic or stone tiles can be installed with a latex modified thin set meeting the ANSI 118.6 standard. Follow mortar manufacturer's recommendations for travel size and open time. Continue to follow the TCA's installation requirements through the remainder of the installation.

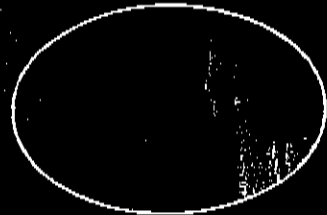

Apply Latex-Modified Thinset & Install Tile

Accessories:

P.W. #6000 water based interior primer concentrate available in 1 and 5 gallon containers.

Technical Data:

Thickness: 110 mils

Color: Grey Top, black adhesive bottom

Elongation: 500% minimum (reuberized adhesive only)

Application Temperature: 45° to 120° degrees Fahrenheit

In Service Temperature: -20 to 180° degrees Fahrenheit

System Performance:

Whisper Mat CS has been tested by the Tile Council of America for system performance in accordance with ASTM C 627 (Robinson Type Floor Tester) and rated for light commercial applications.

Sound Control: Protecto Wrap's Whisper Mat CS has been tested by a certified independent acoustical laboratory in compliance with ASTM E492-90 (Rev. 96) and ASTM E90-97. Test construction included 6" x 6" quarry tiles with latex modified thin set mortar over a 8" concrete slab with a sound rated gypsum board drop ceiling. Test results were Impact Insulation Class IIC 71 and Sound Transmission Class STC 72. Test results with other subfloor configurations are available by contacting Protecto Wrap Company.

Application Standards:

ASTM C6 "Bond Strength of Ceramic Tile to Portland Cement"

ASTM C627 "Robinson Floor Test"

ASTM E492-90 (Rev. 96), "Standard Test Method for Laboratory Measurement of Impact Sound Transmission Through Floor-Ceiling Assemblies using the Tapping Machine"

"Standard Test Method for Laboratory Measurement of Airborne Sound Transmission Loss of Building Partitions and Elements."



1955 South Cherokee Street
www.protectowrap.com

Denver, CO 80223

800-759-9727

Fax 303-777-9273

Protecto Wrap is a member of the following trade organizations:



National Wood Flooring Association



Suppression Membrane for Ceramic and Natural Stone Tile For:

Residential and Commercial Construction

Why Specify Protecto Wrap's Flooring Membranes?

Protecto Wrap Company has been manufacturing membranes since 1952 and has built a sound reputation for producing the highest quality products available. Our sheet membranes meet or exceed sound properties for almost any job specification. Protecto Wrap's strict quality control combined with committed research and development allows for production of the highest quality products available to the flooring and building industries.

Basic Uses: WhisperMat-CS is designed to be an underlayment for ceramic and stone tiles where transmitted or impact sound reduction is required. It may be applied to any structurally sound and clean surface including: concrete, plywood, gypsum underlayments, precast floor panels, OSB, Ceramic tile, terrazzo, natural stone, leveling and patching compounds, cement backer board, existing VAT, VCT and vinyl floors. WhisperMat is approved over radiant heated floors.

Limitations: WhisperMat-CS is not recommended for use on concrete floors when hydrostatic head pressure or excessive water vapor transmission exceeds 4lbs. (tested by "Calcium Chloride Test" method) or where constant water vapor transmission is present. WhisperMat-CS is not recommended for use where horizontal floor movement is greater than 1/4." Existing cracks larger than 3/16" should be prepared with proper backing material prior to installation of membrane. WhisperMat-CS is not recommended to cover joints or cracks larger than 3/8." For installation over plywood substrates and for expansion JOINTS, refer to TCA Handbook F147-99. For expansion joints, reference TCA Method EJ171. Installation procedures and job site conditions must be in accordance with flooring manufacturer's recommendations and TCA installation standards.

Compositions and Materials: WhisperMat-CS is constructed of a top layer of Reinforced Polyester Mesh Fabric embedded into rubberized adhesive, a middle layer of dense cross-linked poly-olefin foam sheathing for additional sound reduction properties with a bottom layer of aggressive rubberized adhesive with an attached release liner for peel & stick application. The membrane is tacky on the bottom providing superior adhesion to concrete, steel and wood substrates. The Polyester mesh fabric top makes an excellent bonding surface for latex modified thin set and medium bed mortars. WhisperMat-CS contains no V.O.C.'s and is environmentally safe which allows it to be used in confined areas. The aggressive rubberized adhesive retains its flexibility throughout the floor's life span and will not dry out or decay with time.

Size: Available in 36" x 40' rolls.

APPLICATIONS

The sound absorption properties combined with the anti-fracture properties makes WhisperMat-CS an excellent system to enhance ceramic and stone flooring installation performance in:

- Condominiums
- Office Buildings
- Apartments
- Hotels
- Single Family Homes
- Schools

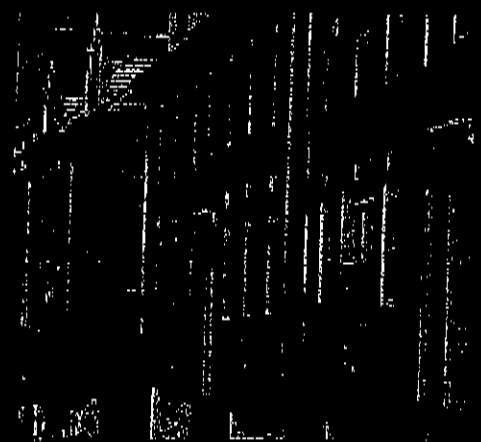



SERVING THE WATERPROOFING INDUSTRY FOR OVER 50 YEARS!

WELCOME | ENERGY PRODUCTS | WATERPROOFING | BUILDING TAPES | ROOFING | FLOORING | PROTECTO TAC | SPECIALTY

FLOORING PRODUCTS

AFM DETAILS

A.F.M.

- ▶ ANTI FRACTURE MEMBRANE
- ▶ AFM DETAILS
- ▶ AFM-WM
- ▶ WATERPROOFING
- ▶ AFM/SCU
- ▶ SOUND CONTROL UNDERLAYMENT FOR CERAMIC TILE
- ▶ SHOWER PAN LINER KIT
- ▶ 6000 PRIMER
- ▶ WHISPER MAT CS
- ▶ SOUND CONTROL UNDERLAYMENT FOR CERAMIC TILE
- ▶ WHISPER MAT HW
- ▶ SOUND CONTROL UNDERLAYMENT FOR HARDWOOD FLOOR
- ▶ DEFENSEAL LIQUID WATERPROOFING & CRACK-ISOLATION MEMBRANE

FRONT VIEW #1

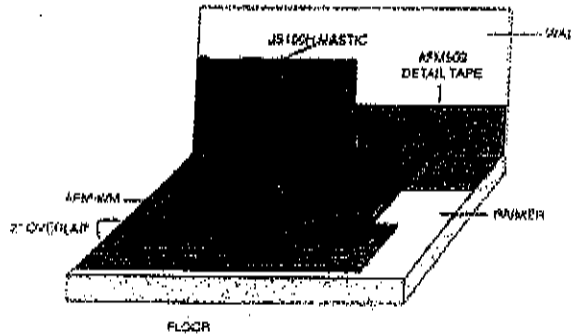

FRONT VIEW #2

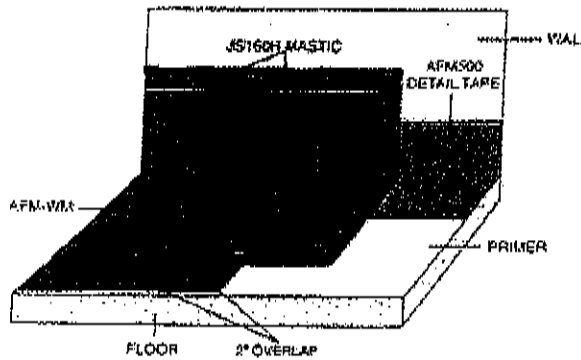

INSIDE CORNER (SIDE VIEW)

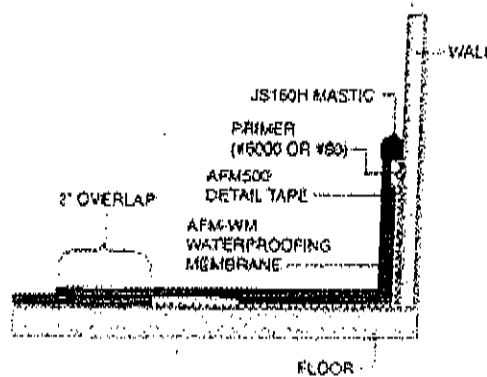

DRAIN DETAIL

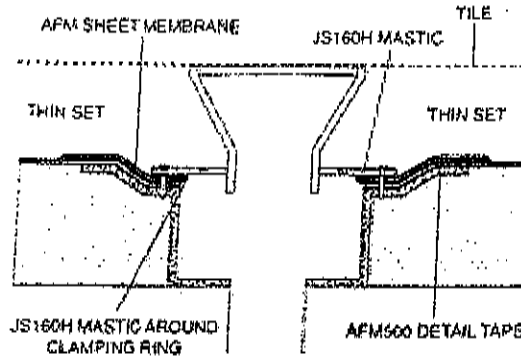

END LAP/T-JOINT

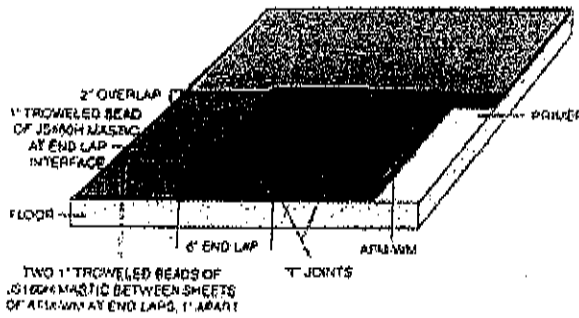

POST & PROTRUSION

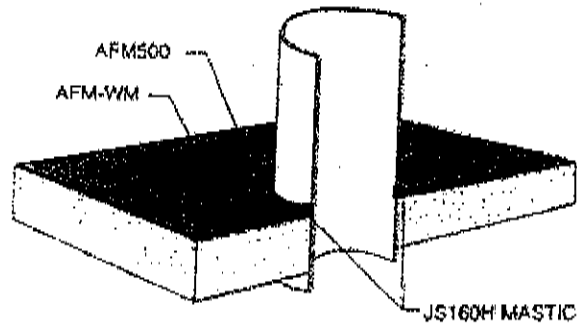



Protecto WhisperMat[®] By



**Sound Control
& Moisture Resistant Membrane
for Engineered Hardwood, Parquet
and Laminate Flooring.**

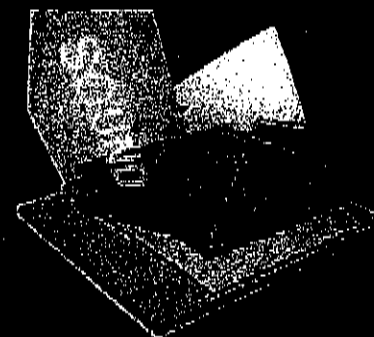

Serious Waterproofing Solutions.

Protecto WhisperMat-HW LLC Sound Control and Moisture

New Construction, Remodeling, Resi

WhisperMat-HW is a peel & stick non-permeable sheet membrane, which reduces impact and airborne sound transmissions and is a moisture/vapor barrier. Designed for use with engineered wood plank, wood parquet and laminate floors. Used where sound control is required, specified or desired.

Constructed of a Cross-Linked Poly-Olefin foam sheet combined with an aggressive rubberized adhesive, WhisperMat-HW combines sound absorption properties with chemical and moisture resistant properties making this an excellent system to enhance flooring installation performance.

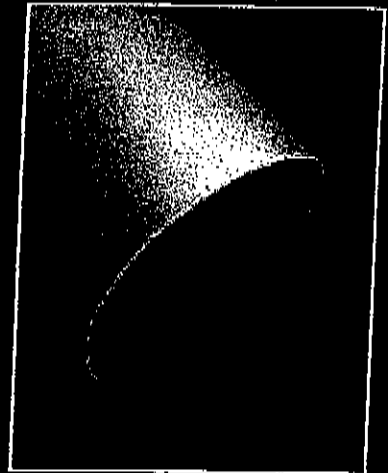

PROPERTIES AND ADVANTAGES

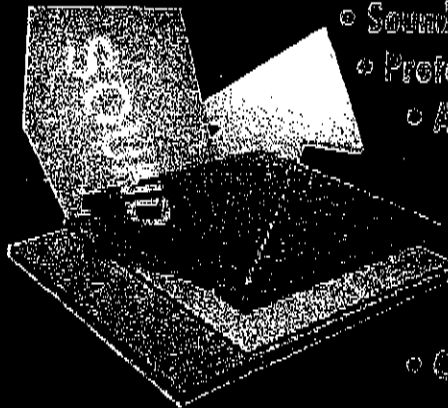

- Sound Reduction: IIC: 72 STC: 71
- Protects flooring from subfloor moisture/vapor emissions
- Approved over Radiant Heated Subfloors
- Economical
- Easy, installer friendly installation
- Uniquely thin System (1/8")
- Commercial and residential applications

WhisperMat HW Composite

Layers in order, top to bottom:

Cross-Linked Poly-Olefin foam

Aggressive Rubberized Adhesive

Release Paper

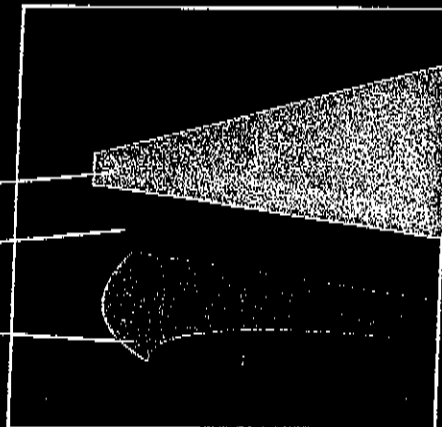

Resistant Membrane for Engineered Hardwood, Parquet and Laminate Flooring For:

Residential and Commercial Construction

Why Specify Protecto Wrap's Flooring Membranes?

Protecto Wrap Company has been manufacturing membranes since 1952 and has built a sound reputation for producing the highest quality products available. Our sheet membranes meet or exceed waterproofing and sound properties for almost any job specification. Protecto Wrap's strict quality control combined with committed research and development allows for production of the highest quality products available to the flooring and building industries.

Basic Uses: WhisperMat-HW underlayment membrane is designed for sound deadening under engineered wood plank, wood parquet and laminate floors. It may be applied to structurally sound and clean surfaces including: concrete, plywood, precast floor panels, OSB, Ceramic tile, terrazzo, natural stone, Portland based leveling and patching compounds, cement backer board, existing VAT, VCT and fully adhered vinyl floors. WhisperMat is approved for installation over radiant heated floors.

Limitations: WhisperMat-HW is not recommended for use on concrete floors where hydrostatic pressure is present or where Moisture Vapor Emissions Rate exceed 4 lbs. WhisperMat-HW is not recommended for use with solid wood plank flooring or any "nail down" only wood floors. Gypsum type patches and levelers are not recommended. Protecto Wrap will not accept responsibility for failures related to use of gypsum underlayment or patching compounds. NOTE: Use only approved wood flooring adhesives (Contact Protecto Wrap for list) Installation procedures and job site conditions must be in accordance with flooring manufacturer's recommendations and IWFA installation standards.

Composition and Materials: WhisperMat-HW is constructed of cross-linked poly-olefin foam sheet fused with an aggressive rubberized adhesive. The membrane is tacky on the bottom providing superior adhesion to concrete, steel and wood substrates. The cross-linked poly-olefin foam top sheet makes an excellent bonding surface for approved wood flooring adhesives. Contact Protecto Wrap for approved adhesive list.

WhisperMat-HW contains no V.O.C.'s and is environmentally safe. The cross-linked poly-olefin foam and its aggressive rubberized adhesive retain its flexibility throughout the floor's life span and will not dry out or decay with time.

Size: Available in 36" x 50' rolls.

APPLICATIONS

The sound absorption properties combined with chemical and moisture resistant properties makes WhisperMat-HW an excellent system to enhance flooring installation performance in:

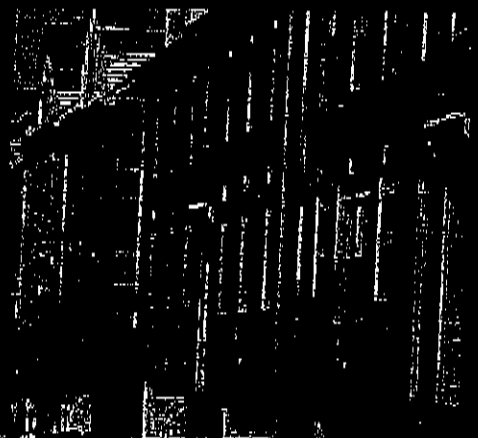

• Condominiums
• Office Buildings

• Apartments
• Hotels

• Single Family Homes
• Schools

INSTALLATION:

Follow wood flooring manufacturers recommended installation instructions as to fully adhered or floating floor installation guidelines. Installation must also conform to NWFA standards.

Wood flooring and WhisperMat-HW membrane must acclimate to job site conditions before installation. Concrete subfloors must be dry, clean and free of dirt, grease, wax, paint, oil or anything that would adversely affect adhesion of the WhisperMat.

Subfloors must be checked for excessive moisture. If subfloor moisture/vapor is higher than 4lb. Emissions, WhisperMat-HW membrane cannot be used (see "Limitations"). Subfloors must be flat to 3/16" in a 10' radius. Leveling cements must be completely dry before membrane application.

Priming the subfloor: Always apply the Protecto Wrap #6000 primer to the subfloor and allow to dry (approx 20-30 min.) before installing the WhisperMat-HW to ensure a good bond.

Unroll WhisperMat-HW with the release liner side down. Cut the length approximately 12" longer than the distance to be covered to allow for a trimmed fit. Fold back half of the length of the roll back over the other half of the material. Score through the release liner only, taking care not to cut completely through membrane. Pull release liner away from membrane where scored. As the release liner is pulled away, hand-smooth the membrane to contact the primed subfloor. Keep the release liner material close to the floor while pulling away, this will allow for a more controlled application of the membrane.

Take note: there will be an immediate and aggressive bond of the membrane to the primed subfloor. Realignment of the membrane can be difficult once adhered to the subfloor.

Waterproofing Applications: Installations requiring waterproofing characteristics must have a topical application of AFMA LM liquid anti-fracture and waterproofing membrane at the seams of the WhisperMat-HW. Using a 3/8" nap point roller, apply a liberal thickness, 6" wide layer of the liquid membrane over the seam (3" of liquid membrane to overlap onto both sides of where the edges of the WhisperMat-HW meet.) Be sure to have the seam completely covered with liquid membrane with no gaps. Allow the liquid membrane to cure fully before installing the wood flooring.

Approved Wood Adhesives: Approved wood flooring adhesives work well. Most latex and acrylic based wood floor adhesives which are compatible with foam sheeting are approved. Contact Protecto Wrap for approved adhesive list. Protecto Wrap is not liable for failures due to use of unapproved adhesives. (Solvent based adhesives and most urethane adhesives are not compatible with WhisperMat-HW. Some water-based adhesives do not bond sufficiently to the membrane surface.)

Spread the approved adhesive onto the adhered WhisperMat membrane in accordance with manufacturer's recommendations for travel size and open time. Adhesive flash time may be longer when used over WhisperMat-HW than over concrete or wood subfloors due to the membrane's non-porous construction. Continue to follow wood flooring manufacturer's installation recommendations through the remainder of the flooring installation.

Approved Wood Adhesives

Use only approved wood flooring adhesives (Contact Protecto Wrap for list). Urethane adhesives are not approved for use with WhisperMat-HW. Installation procedures and job site conditions must be in accordance with flooring manufacturer's recommendations and NWFA installation standards.

Apply Primer

Cut to Correct Length

Remove & Press in Place

Apply Approved Adhesive & Install Wood Flooring

Accessories:

PVC #6000 water based interior primer concentrate

Technical Data:

Thickness: 1/8"

Color: Tan top, black adhesive bottom

Elongation: 500% minimum (rubberized adhesive only)

Application Temperature: 50° to 85° Fahrenheit

ASTM - F90-97

System Performance: Sound Control:

WhisperMat-HW has been tested by certified independent acoustical laboratories in compliance with ASTM-E492-90 and ASTM-E90-97. Test construction included 3/8" engineered wood flooring over an 8" concrete slab with a sound rated gypsum board drop ceiling. Test results were Impact Insulation Class IIC 72 and Sound Transmission Class STC 71. Test results with other subfloor configurations are available by contacting Protecto Wrap Company.

Application Standards:

ASTM E492-90 (Rev. 96), "Standard Test Method for Laboratory Measurement of Impact Sound Transmission Through Floor-Ceiling Assemblies using the Tapping Machine"

ASTM E90-97, "Standard Test Method for Laboratory Measurement of Airborne Sound Transmission Loss of Building Partitions and Elements."

Protecto
Wrap

1955 South Cherokee Street
www.protectowrap.com

Denver, CO 80223

800-759-9727

Fax 303-777-9273

Protecto Wrap is a member of the following trade organizations:



National
Wood Flooring
Association





SERVING THE WATERPROOFING INDUSTRY FOR OVER 50 YEARS!

WELCOME ENERGY PRODUCTS WATERPROOFING BUILDING TAPES ROOFING FLOORING PROTECTO-TAC SPECIALTY

11230

FLOORING PRODUCTS AFM DETAILS A.F.M.

- ▶ ANTI FRACTURE MEMBRANE
- ▶ AFM DETAILS
- ▶ AFM-WM WATERPROOFING
- ▶ AFM/SCU SOUND CONTROL
- ▶ SHOWER PAN LINER KIT
- ▶ 6000 PRIMER
- ▶ WHISPER MAT CS SOUND CONTROL UNDERLAYMENT FOR CERAMIC TILE
- ▶ WHISPER MAT HW SOUND CONTROL UNDERLAYMENT FOR HARDWOOD FLOOR
- ▶ DEFENSEAL LIQUID WATERPROOFING & CRACK-ISOLATION MEMBRANE

FRONT VIEW #1

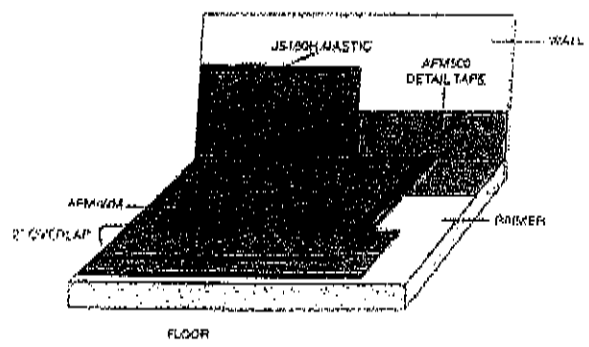

FRONT VIEW #2

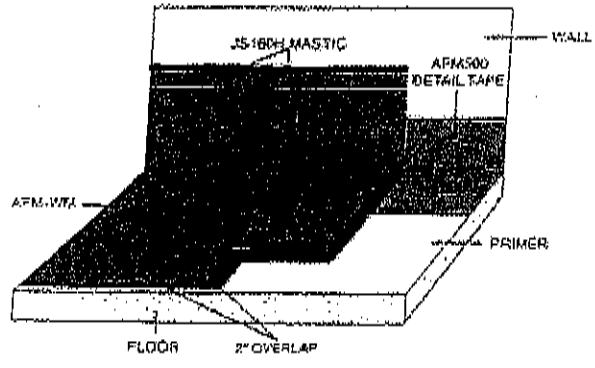

INSIDE CORNER (SIDE VIEW)

